



Cover 1:  
Aero Fawn

Cover 2:  
Aero Fawn

Dark Wood Feet

# Newark Collection

Colours represented are to be used as a guide only.  
Please refer to manufacturers swatch for a more accurate colour match.

Please note that colour shadings can vary slightly from each roll of fabric.  
We cannot guarantee a precise match to these samples or between cut lengths and upholstered goods.

**Extra Flex**<sup>®</sup>  
Soft, Supportive Seating

29/04/2021

# NEWARK COVER GUIDE - PILLOW BACK & STANDARD BACK

Please use this guide when ordering the following pieces to clarify cover options.

## STANDARD BACK

LH2, COR, RH2 Corner Group

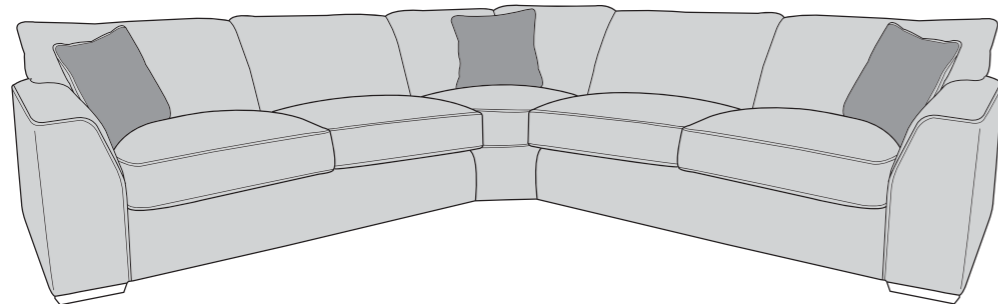

LH1, COR, RH1 Corner Group

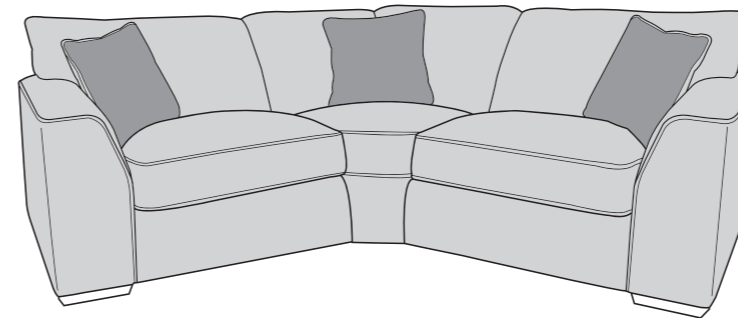

LH2, COR, RH1 Corner Group

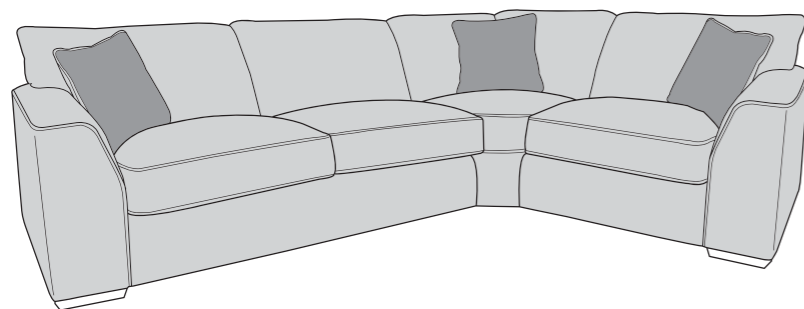

LH1, COR, RH2 Corner Group

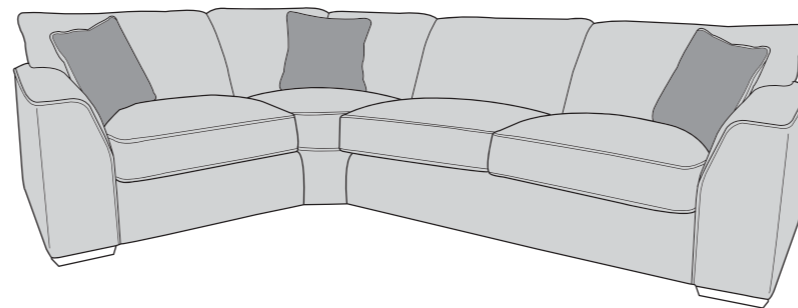

Armless Unit (ALU)

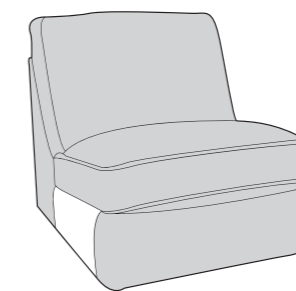

3 Seater sofa (3ST)

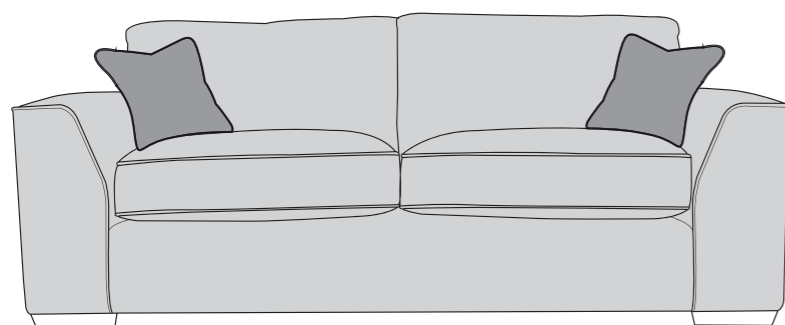

2 Seater sofa (2ST)

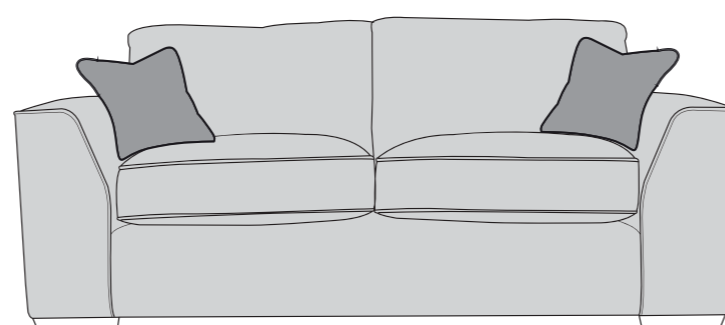

Arm Chair (1ST)

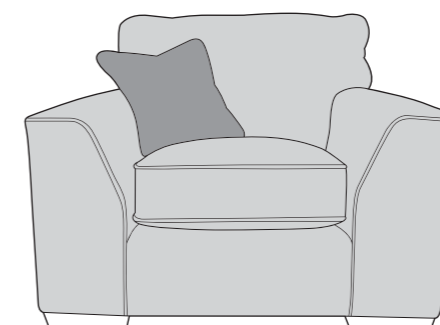

Scatter Cushions

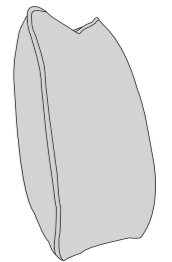

Front = Cover 2  
Piping = Cover 1  
Back = Cover 1





# NEWARK DIMENSIONS (CM)

AVAILABLE PIECES	HEIGHT 1	OUTBACK HEIGHT	WIDTH 2	DEPTH 3	WEIGHT (KG)	SCATTER CUSHION NO.
LH2, COR, RH2 GROUP	90	74	295	295	N/A	3
LH1, COR, RH1 GROUP	90	74	211	211	N/A	3
LH2, COR, RH1 GROUP or LH1, COR, RH2 GROUP	90	74	295	211	N/A	3
LH2/RH2 UNIT	90	74	189	103	N/A	1
LH1/RH1 UNIT	90	74	105	103	N/A	1
CORNER UNIT (COR)	90	74	106	106	N/A	1
ARMLESS UNIT (ALU)	90	74	78	103	N/A	N/A
3 SEATER SOFA (3ST)	90	74	215	103	N/A	2
2 SEATER SOFA (2ST)	90	74	188	103	N/A	2
ARM CHAIR (1ST)	90	74	114	103	N/A	1

\* Hardwood & composite board frame.

\* ExtraFlex high comfort seat cushions.

\* Serpentine seat springs and silent wire.

\* Dowelled, screwed, glued & stapled joinery.

\* Reversible fibre filled backs for added comfort.

\* Elasticated back webbing.

## DIMENSION GUIDE

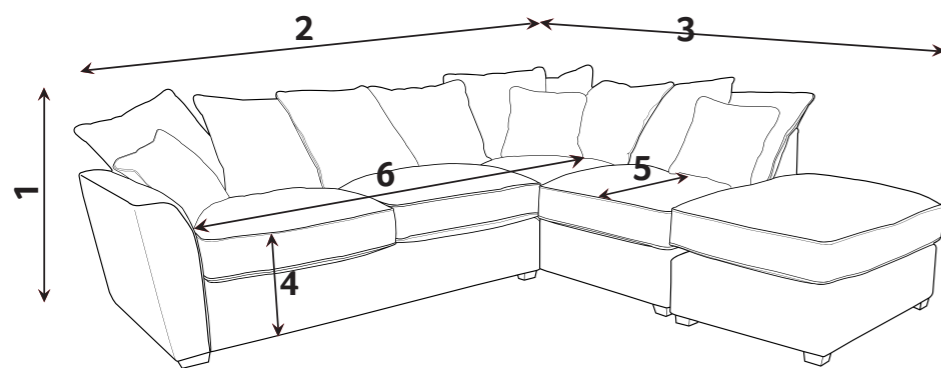

1 - HEIGHT  
2 - WIDTH

3 - DEPTH  
4 - SEAT HEIGHT

5 - SEAT DEPTH (STD & PILLOW)  
6 - SEAT WIDTH

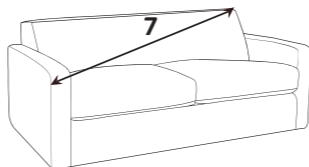

Check the diagonal access dimension to ensure furniture will fit in your home.

7 - DIAGONAL ACCESS

Illustrations used for reference only.

## Extra Flex®

A high density foam base seat interior with a hand-rolled carded fibre, channelled topper which provides both softness and support.

## CARE GUIDE

Extraflex seat cushions should be **plumped up on a regular basis** to help maintain the aesthetical appeal of your upholstery, the plumping of cushions is essential to help retain the comfort and softness of any piece of upholstered furniture.

To improve the longevity of your hand-made furniture, we recommend rotating cushions (where applicable).

For further information on maintaining your furniture please refer to the care guide located under the seat platform.

Dark (Brown)

Light (Beech)

FOOT OPTIONS:

